

CannonBall:HNP Quick-Track™ Door Track System

Combines all the features of CannonBall:HNP Track/Trolley Systems with the benefits of one-piece installation.

Fast, easy assembly provides beauty and long-lasting weather resistance. Cover is 18 gauge white baked enamel.

Use with wood or metal door frames in any agricultural or commercial building construction.

Quick-Track™ System featuring:

- Top-mounted 14 gauge galvanized track with heavy 18 gauge white cover designed to give weather protection for doors up to 5" in thickness.
- An interlocking cover to fit snug and smooth.
- All CannonBall round track trolley systems can be used.
- End cap and trim complete a professional, trouble-free installation.
- Quick-Track™ available in 8-20 ft. lengths.

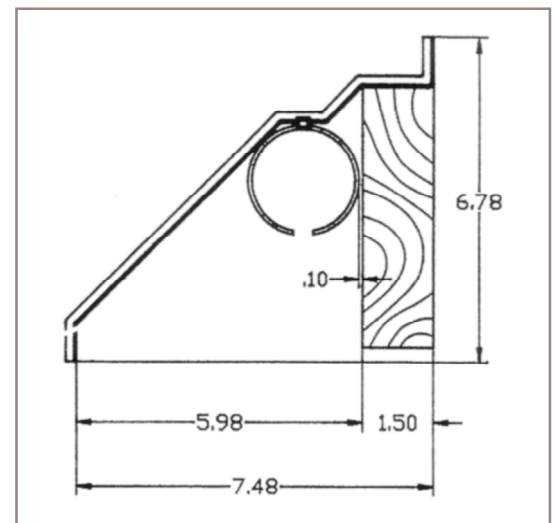
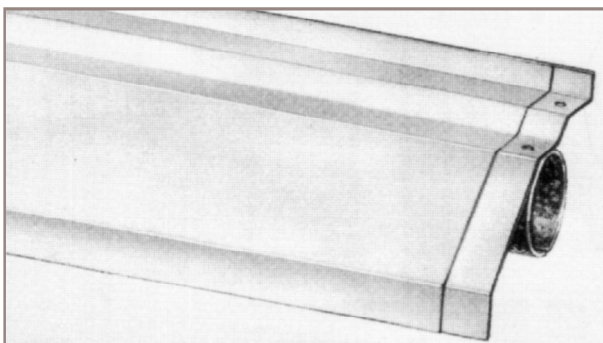
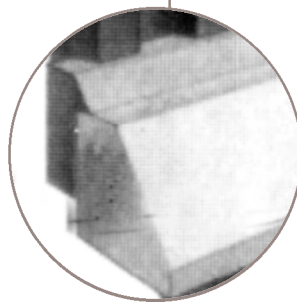
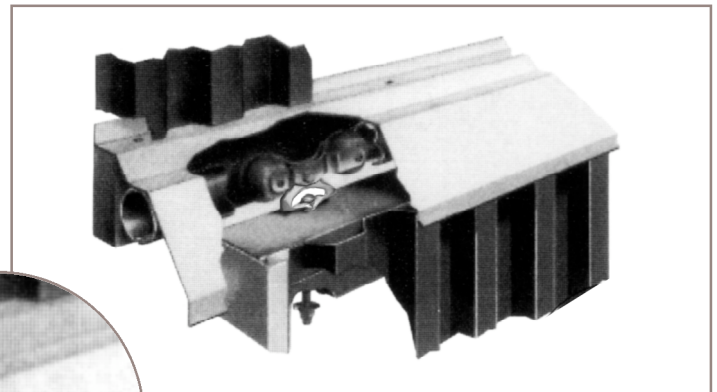

555 Lawton Avenue, P.O. Box 835 | Beloit, Wisconsin 53512-0835
 Phone: 608-365-2161 | Fax: 608-365-4565 | Toll Free: 800-766-2825
www.cnbhnp.com

CannonBall:HNP Quick-Track™ Ordering Information

PART N.O.	LENGTH	DESCRIPTION	UNIT PKG.	SHIPPING WT.
711158	8 ft.	Quick-Track™ System	Pair	32 lbs.
711159	10 ft.	Quick-Track™ System	Pair	40 lbs.
711160	12 ft.	Quick-Track™ System	Pair	48 lbs.
711161	14 ft.	Quick-Track™ System	Pair	56 lbs.
711162	16 ft.	Quick-Track™ System	Pair	64 lbs.
711163	18 ft.	Quick-Track™ System	Pair	72 lbs.
711164	20 ft.	Quick-Track™ System	Pair	80 lbs.

ACCESSORIES

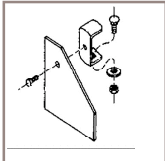
465101		Splice Collar, one required for each section of track less one.	Each	.6 lbs./Each
711205		Standard End Cap, two pieces of white painted end trim with mounting brackets and hardware.	Pair	.6 lbs./Pair

Recommendation: Mounting holes every 4 inches. Use 1-1/2" 10 gauge ring shank nails with 3/8" head with rubber or silicone washers.

TROLLEYS AND HANGERS TO CHOOSE FROM:

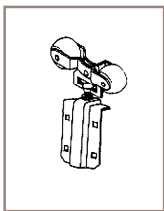

Strap trolley with bearings for wood doors up to 400 lbs. Available with single or double straps.

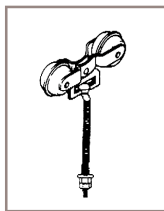

Pendant bolt trolleys for all doors up to 600 lbs. Bolts available in various styles.

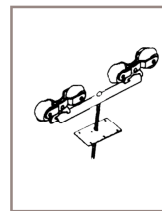

Double truck trolleys with tandem bar for doors up to 1200 lbs. Available with pendant bolt and mounting plate.

*NOTE: Weight limitations apply to Quick-Track™ Installations only.

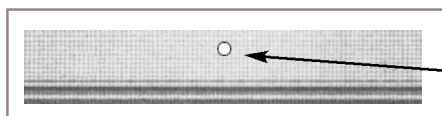

For Bigg Frame™ only - pendant bolt hole must be off-center for proper clearance.