



SQUARE DOOR TRACK *Systems*



door track systems

SQUARE-TRACK™ *System*

Square track from CannonBall:HNP is designed for flexibility and economy in sliding door systems weighing up to 400 lbs. Suitable for use indoors or out, CannonBall square track can be installed with or without a cover in top mount, face mount, and double-run face mount configurations.

Manufactured from 16 gauge galvanized steel, CannonBall square track is available in length from 8 to 20 feet.

All models of CannonBall square track are compatible with our full family of non-bearing, Delrin bearing and roller bearing trolley hangers.



PLAIN SQUARE TRACK	
Part #	Length
727976	8
727977	10
727978	12
714027	14
713935	16
714229	18
713986	20

FNF SQUARE TRACK SYSTEM

The FNF Square Track System from CannonBall:HNP features a unique bracket design suitable for Flashing or No Flashing applications.

Mounting brackets are pre-riveted to the track for quick and easy installation with no obstructions. A separate flashing bracket can be tapped into slots of the mounting brackets if flashing is needed.

FNF Square Track is made from our standard square track allowing use of all existing CannonBall square track hangers and accessories. Suitable for use on sliding doors weighing up to 400 lbs.

Available in top and face mount configurations in lengths from 8 to 20 feet. The same flashing bracket is used for both top and face mount FNF tracks.

Provides the ease of installation of a snap-on flashing bracket with strength comparable to a one-piece flashing bracket.



SQUARE TRACK W/ TOP MOUNT FNF BRACKETS

Part #	Length
714781	8
715174	10
715175	12
715176	14
714782	16
715177	18
715178	20

SQUARE TRACK W/ FACE MOUNT FNF BRACKETS

Part #	Length
715085	8
715086	10
715087	12
715088	14
715089	16
715090	18
715091	20

TOP MOUNT BRACKET SQUARE TRACK

The most popular square track type on the market today, Top Mount Bracket Square Track is strong, durable and easy to install.

Manufactured using our standard square track, Top Mount Bracket Square Track is compatible with all existing CannonBall square track hangers and accessories and is suitable for use on sliding doors weighing up to 400 lbs.

The one-piece, top mount brackets allow for clear access to mounting holes, provide a solid hold point for positioning and handling the track, and cannot be blown apart by high winds.

Top mounts brackets feature a wide design for greater contact between bracket and flashing for maximum strength.

Top Mount Bracket Square Track is available in lengths from 8 to 20 feet.

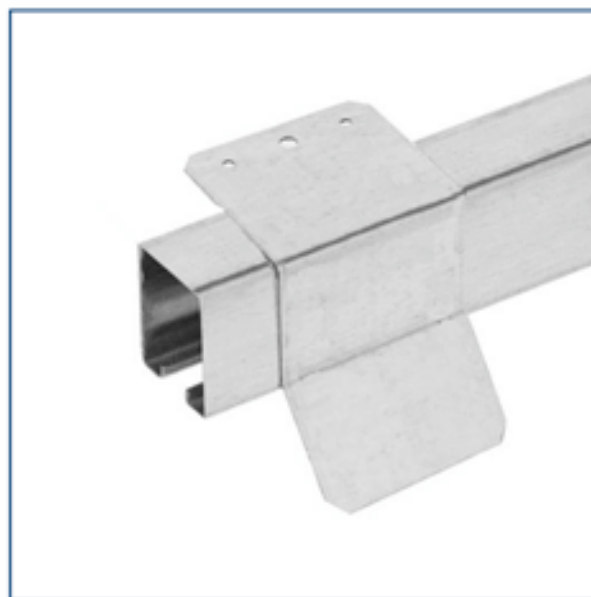

TOP MOUNT BRACKET SQUARE TRACK	
Part #	Length
714017	8
714018	10
714019	12
714025	14
714020	16
714030	18
714021	20

WHITE COVER AND GALVANIZED COVER TRACK

Covered Square Track from CannonBall:HNP offers the ultimate in ease of installation – line it up, fasten it, and you're done.

Heavy duty track cover is pre-riveted to track for maximum strength and fast installation.

Top Mount White Covered Track features a durable, baked-on white finish that accents most building colors – no additional painting required.

Face Mount Galvanized Covered Track can be painted in the field to match any building color, or can be left unpainted if desired.

Manufactured from our standard square track, all covered square tracks are compatible with the full family of CannonBall hangers and accessories, and are suitable for sliding doors weighing up to 400 lbs.

Both track styles are available in lengths from 8 to 20 feet.

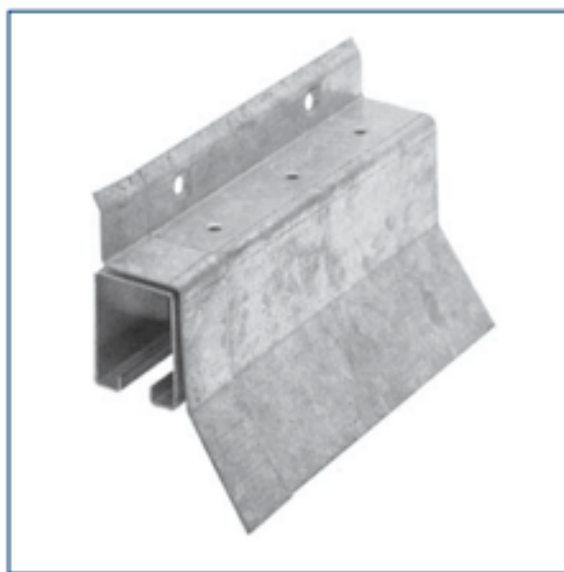

**SQUARE TRACK WITH TOP
MOUNT WHITE COVER**

Part #	Length
713937	8
713957	10
713958	12
714061	14
713959	16
714219	18
713960	20

**SQUARE TRACK WITH FACE
MOUNT GALVANIZED COVER**

Part #	Length
714012	8
714013	10
714014	12
714024	14
714015	16
714031	18
714016	20

door track systems

TROLLEYS

All CannonBall:HNP Square Track Trolley Hangers are designed for use in pairs on sliding doors weighing up to 400 lbs.

Pendant bolt trolleys are suitable for use on all types of sliding doors. A hole is drilled in the top horizontal of the door for attaching the bolt. The offset of the bolt allows for 4-way adjustment of the door.

Easy Adjust trolley hangers feature a straight pendant bolt mounted on a separate adjustment bolt. The pendant bolt provides vertical adjustment while the adjustment bolt is used to adjust the door in or out from the building. Easy Adjust trolleys also feature a removable pin to allow for the trolley to be installed in the track separate from the door – lift the door and reinstall the pin for easy installation.

Strap trolleys are designed for use with wood doors. A variety of straps are available for various door, installation and adjustment options. Straps bolt through the face of the door and attach to the trolley using a modified pendant bolt.

Bolt Thru trolleys are designed for applications where only vertical adjustment is required.



Pendant Bolt Trolley



Easy Adjust Trolley



Strap Trolley



Bolt Thru Trolley

Non-Bearing Trolleys – Economical design with no bearings to wear out over time or fail.

Delrin Bearing Trolleys – Still economical but provides easier and quieter operation of the door.

Roller Bearing Trolleys – Our best trolleys, provide easiest operation and are virtually noise free.

SQUARE TRACK SYSTEMS

	Part No. Description	Ship Wt.	Unit Pkg.
	<p>Plain Square Track. 16 Ga. Galvanized track for making single or double track runs. For doors weighing no more than 400 lbs.</p>	1.7 lbs/ft.	pair
	<p>Square Track w/ Face Mount FNF Brackets. Galvanized track with face mount brackets attached 4" from each end and space 24" on center.</p>	2 lbs/ft.	each
	<p>Square Track w/ Top Mount FNF Brackets. 16 ga. galvanized track with top mount brackets attached 4" from each end and spaced 24" on center.</p>	2 lbs/ft.	each
	<p>Square Track w/ Top Mount Brackets. 16 Ga. galvanized track with top mount brackets attached 4" from each end and spaced 24" on center.</p>	2 lbs/ft.	each
	<p>Square Track w/ Face Mount Galvanized Cover. One piece construction for easy installation. No additional flashing or mounting brackets required. Packaged 2 per carton - a broken package fee will be applied to all broken package quantities.</p>	3.3 lbs/ft.	pair
	<p>Square Track w/ Top Mount White Cover. One piece construction for easy installation. No additional flashing or mounting brackets required. Packaged 2 per carton - a broken package fee will be applied to all broken package quantities.</p>	3.2 lbs/ft.	pair
	<p>714918 90 Degree Track Curve. 90 degree curve for use when door width exceeds two times the wall length. Brackets must be ordered separately. Compatible with all CannonBall:HNP square track brackets. For use with all 16ga. square track systems.</p>	10 lbs/each	each









SQUARE TRACK TROLLEY HANGERS

	Part No. Description	Ship Wt.	Unit Pkg.
	Non-Bearing Trolleys with Saddle and Stirrup		
	714000 Trolley only, no hanger For use with all square track systems. Includes end caps. Non-bearing trolleys for doors not weighing more than 400#.	5.3 lbs/pair	pair
	714004 9\" data-bbox="214 279 604 324"/>	4.7 lbs/pair	pair
	714008 Single Adj.Strap for Wood Doors For use with all square track systems. Includes end caps. Non-bearing trolleys for doors not weighing more than 400#.	6.0 lbs/pair	pair
	Rigid Roller-Bearing Trolleys (no Saddle or Stirrup)		
	714247 Trolley only, no hanger For use with all square track systems. Includes end caps. Roller bearing trolleys for doors not weighing more than 400#.	4.7 lbs/pair	pair
	715145 Trolley with eye-bolt hanger For use with all square track systems. Includes end caps. Roller bearing trolleys for doors not weighing more than 400#.	4.8 lbs/pair	pair
	715146 3\" data-bbox="214 682 614 727"/>	4.8 lbs/pair	pair
	714387 6\" data-bbox="214 778 614 823"/>	5.1 lbs/pair	pair

SQUARE TRACK TROLLEY HANGERS



Part No.	Description	Ship Wt.	Unit Pkg.
Roller-Bearing Trolleys with Saddle and Stirrup			
	<p>714005 9-1/2" 4-Way Adj. "Pendant Bolt" Trolley. For use with all square track systems. Roller bearing trolleys for doors no weighing more than 400#.</p>	4 lbs/pair	pair
	<p>714010 Single Adj. Strap for Wood Doors. For use with all square track systems. Roller bearing trolleys for doors no weighing more than 400#.</p>	5.3 lbs/pair	pair
	<p>714963 Adjustable Strap Trolleys - front and rear straps. For use with all square track systems. Roller bearing trolleys for doors no weighing more than 400#.</p>	6.0 lbs/pair	pair
EZ-Adjust Roller-Bearing Trolleys with Quick-Release Pin			
	<p>714253 9" 4-way Adj. Pendant Bolt Trolley. For use with all square track systems. Includes end caps. Roller bearing trolleys for doors not weighing more than 400#.</p>	4.4 lbs/pair	pair
	<p>714942 Front and Rear Adj. Straps for Wood Doors. For use with all square track systems. Includes end caps. Roller bearing trolleys for doors not weighing more than 400#.</p>	5.3 lbs/pair	pair

SQUARE TRACK TROLLEY HANGERS





	Part No. Description	Ship Wt.	Unit Pkg.
	Rigid Delrin-Bearing Trolleys (no Saddle or Stirrup)		
	714919 Trolley only, no hanger For use with all square track systems. Includes end caps. Delrin bearing trolleys for doors not weighing more than 400#.	4.4 lbs/pair	pair
	715136 Trolley with eye-bolt hanger For use with all square track systems. Includes end caps. Delrin bearing trolleys for doors not weighing more than 400#.	4.0 lbs/pair	pair
	715137 Trolley w/ 4" Sraight bolt-thru hanger For use with all square track systems. Includes end caps. Delrin bearing trolleys for doors not weighing more than 400#.	5.0 lbs/pair	pair
	715140 Trolley w/ 6" Sraight bolt-thru hanger For use with all square track systems. Includes end caps. Delrin bearing trolleys for doors not weighing more than 400#.	4.7 lbs/pair	pair
	714943 9" 4-way Adj. Pendant Bolt Trolley Pair For use with all square track systems. Includes end caps. Delrin bearing trolleys for doors not weighing more than 400#.	5.3 lbs/pair	pair
	715128 Trolley w/ 8" Sraight bolt-thru hanger For use with all square track systems. Includes end caps. Delrin bearing trolleys for doors not weighing more than 400#.	4.7 lbs/pair	pair
	715129 Single Adj. Strap for Wood Doors For use with all square track systems. Includes end caps. Delrin bearing trolleys for doors not weighing more than 400#.	5.3 lbs/pair	pair
	715141 Trolley w/ Adj. front and rear straps For use with all square track systems. Includes end caps. Delrin bearing trolleys for doors not weighing more than 400#.	6.0 lbs/pair	pair

door track systems



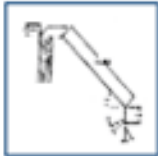

SQUARE TRACK TROLLEY HANGERS

Part No.	Description	Ship Wt.	Unit Pkg.
Delrin-Bearing Trolleys with Saddle and Stirrup			
	<p>715127 Trolleys only, no hanger. For use with all square track systems. Delrin bearing trolleys for doors not weighing more than 400#.</p>	4.4 lbs/pair	pair
	<p>714943 9" 4-way Adj. Pendant Bolt Trolley Pair. For use with all square track systems. Delrin bearing trolleys for doors not weighing more than 400#.</p>	5.3 lbs/pair	pair
	<p>715142 7-1/2" 4-way Adj. Pendant Bolt Trolley Pair. For use with all square track systems. Delrin bearing trolleys for doors not weighing more than 400#.</p>	5.3 lbs/pair	pair
	<p>715143 Single Adj. Strap for Wood Doors. For use with all square track systems. Delrin bearing trolleys for doors not weighing more than 400#.</p>	5.3 lbs/pair	pair
	<p>715144 Adj. Strap Trolley with Front and Rear Straps. For use with all square track systems. Delrin bearing trolleys for doors not weighing more than 400#.</p>	6.0 lbs/pair	pair
	<p>714990 Outside Adj. Single Strap Trolley. For use with all square track systems. Delrin bearing trolleys for doors not weighing more than 400#.</p>	5.3 lbs/pair	pair

SQUARE TRACK SYSTEMS









	Part No. Description	Ship Wt.	Unit Pkg.
	714777 FNF Flashing Bracket . Flashing bracket for use with both face mount and top mount FNF Track Systems.	.4 lbs/each	each
	714026 Flashing Bracket . Provides support for flashing at ends of track when flashing is extended beyond end of track run.	.5 lbs/each	each
	712136 Cover Retainer Bracket . Designed for easy installation of track cover for either single or double runs of bolt-hung track	.4 lbs/each	each
	714425 White Cover for Double Track Runs . Not responsible for shipping damage when ordered in quantities of less than 20. A 10% broken package charge will be added to orders of less than 20. To be used with #712137 bracket and #712136 cover retainer bracket.	12 lbs/each	each
	714366 End Cap . Two required for each track run.	.1 lb/each	each
	714946 End Cap . Two required for each track run.	.2 lbs/each	each

SQUARE TRACK HARDWARE

	Part No. Description	Ship Wt.	Unit Pkg.
	<p>727979 Face Mount Brackets (Track Only). Made from heavy gauge galvanized, requires 3/8" lag screw or bolt for mounting. Recommended spacing is 24" O.C. Also works as a splice collar. Lug needs to be knocked out when used as splice collar.</p>	.8 lbs./each	each
	<p>714976 - right hand, 714977 - left hand Face Mount End Brackets (w/ Welded End Cap). Made from heavy gauge galvanized, requires 3/8" lag screw or bolt for mounting. Recommended spacing is 24" O.C. Welded end cap seal end of track.</p>	.4 lbs./each	each
	<p>714944 Face Mount Locking Splice Bracket (w/ Lock Bolts). Galvanized bracket includes lags to lock track into position when used as a splice. Requires lag screws or bolts for mounting. Recommended spacing is 24" O.C.</p>	.9 lbs./each	each
	<p>714945 Face Mount Double Brackets (Track Only). Zinc plated for mounting two parallel runs of track. Usually used for bypassing doors.</p>	2.8 lbs./each	each
	<p>715131 Face Mount Double Splice Brackets (Track Only). Zinc plated for splicing two parallel runs of track. Usually used for bypassing doors.</p>	3.0 lbs./each	each
	<p>714948 Ceiling Mount Bracket. Galvanized bracket requires 3/8" leg screw or bolt for mounting. Recommended spaces is 24" O.C. Mounts to ceiling.</p>	0.4 lbs./each	each
	<p>714022 Bolt Hung Track Bracket. Heavy gauge galvanize, includes 3/8" bolt and nut for mounting overhead single or double track runs. Recommended spacing is 24" O.C.</p>	.9 lbs./each	each
	<p>714023 Bolt Hung Splice Bracket. Same as 714022 only with added clamping feature to hold joining ends of track in alignment.</p>	1 lb./each	each

door track systems

SQUARE TRACK HARDWARE

	Part No. Description	Ship Wt.	Unit Pkg.
	712138 Face Mount Bracket. Galvanized brackets for mounting all Square Track systems.	1 lb./each	each
	712137 Double Track Bracket. Galvanized brackets for mounting all Square Track systems.	3 lbs./each	each
	715081 Face Mount Single Track Bracket. Galvanized brackets for mounting all Square Track systems. Brackets are assembled and are designed for use with flashing retainer bracket 712136.	0.5 lbs./each	each
	715083 Face Mount Single Splice Bracket. Galvanized brackets for mounting all Square Track systems. Brackets are assembled and are designed for use with flashing retainer bracket 712136.	0.7 lbs./each	each
	715082 Face Mount Double Track Bracket. Galvanized brackets for mounting all Square Track systems. Brackets are assembled and are designed for use with flashing retainer bracket 712136.	0.7 lbs./each	each
	715084 Face Mount Double Splice Bracket. Galvanized brackets for mounting all Square Track systems. Brackets are assembled and are designed for use with flashing retainer bracket 712136.	1.1 lbs./each	each
	714864 Face Mount Double Track Bracket with Cover Retainer. Galvanized brackets for mounting all Square Track systems. Brackets are assembled and are designed for use with flashing retainer bracket 712136.	0.8 lbs./each	each
	714865 Face Mount Double Splice Bracket with Cover Retainer. Galvanized brackets for mounting all Square Track systems. Brackets are assembled and are designed for use with flashing retainer bracket 712136.	1.2 lbs./each	each

PUT YOUR INVENTORY RIGHT OUT FRONT WITH CANNONBALL:HNP RETAIL DISPLAY CENTERS



With Retail Displays from CannonBall:HNP, your customers can easily find all the right components to complete the job right. Featuring an assembled and functional display header, our Retail Displays can be easily tailored for the product lines you carry to maximize your sales potential. A variety of display headers are available to support sales of all CannonBall:HNP product lines. Ask your Sales Representative today, and put your inventory right out front with CannonBall:HNP Retail Displays.

door track systems

KWIK-FRAME™ *Sliding Door System*

For Typical Openings & Wind Load Conditions

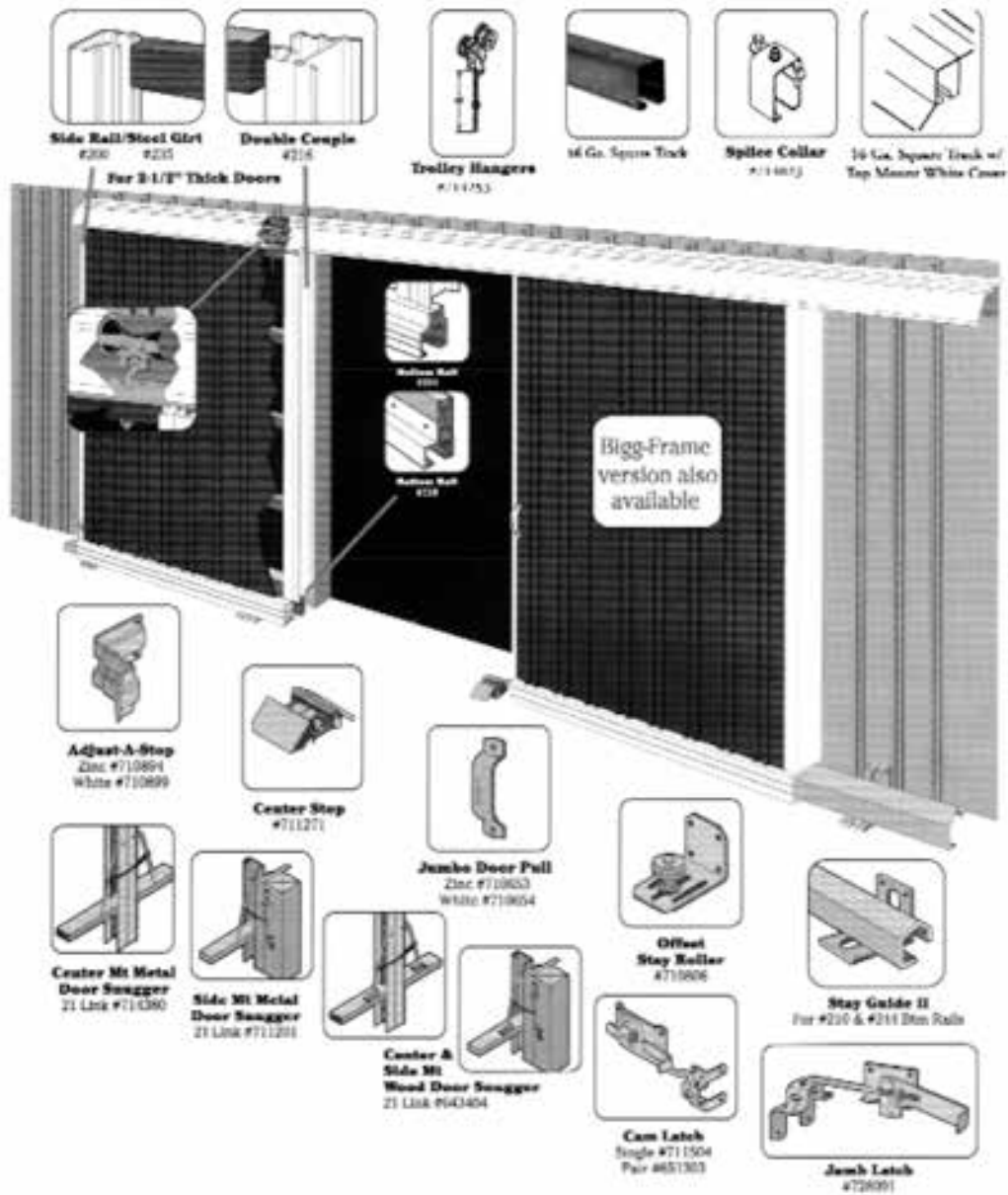

CNB-ST-BK001

555 Lawton Avenue | Beloit, Wisconsin 53512-0835
 Phone: 608-365-2161 | Fax: 608-365-4565 | Toll Free: 800-766-2825 | www.cnbhnp.com